

Making the Smart Grid Real



Soluciones nacidas de la experiencia y el liderazgo tecnológico

Haciendo realidad la red del futuro desde 1993



En ZIV innovamos para aportar soluciones inteligentes:



1 para las redes de Transmisión & Distribución



2 para las redes de Media y Baja Tensión (DAS)



3 soluciones avanzadas de Medida



4 + soluciones de Recarga de VE



5 Y formación online para clientes y distribuidores

Un Partner Internacional de confianza 
Follow us

ZIV nació en 1993 para proporcionar soluciones innovadoras a la industria eléctrica.

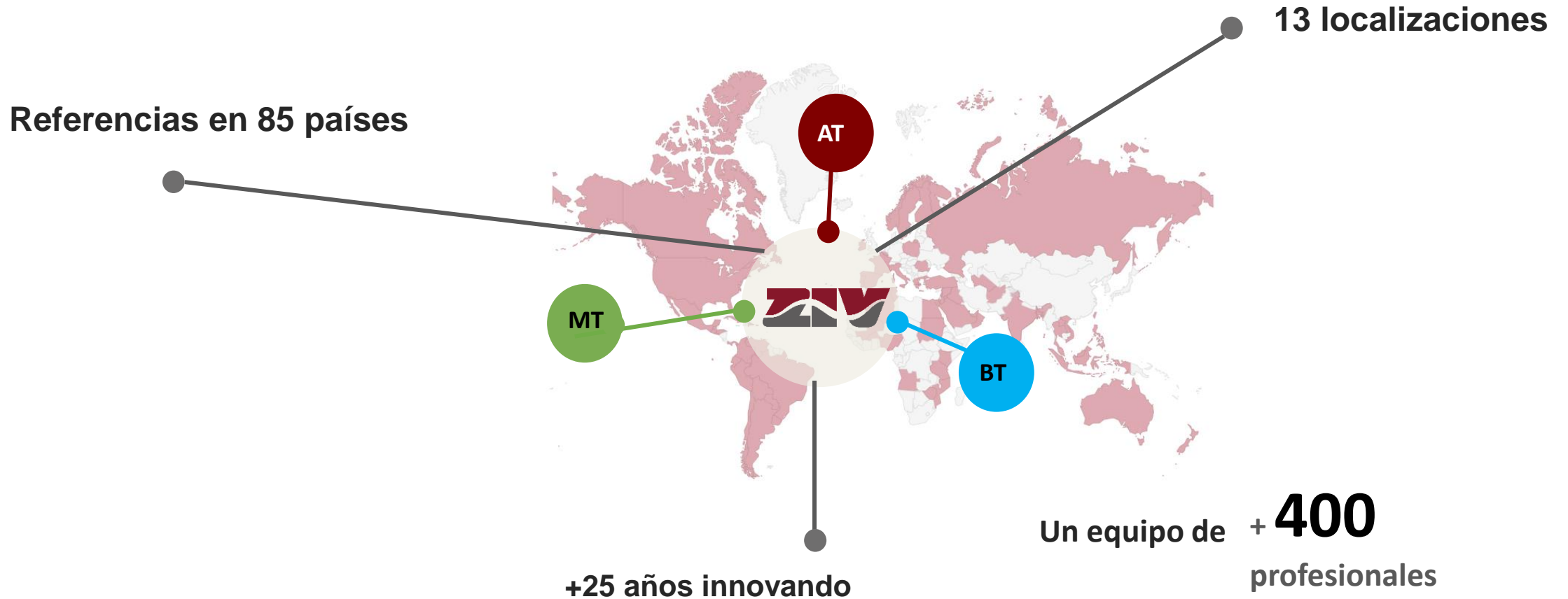

Apostando por los estándares internacionales y la innovación continua



Participamos en los principales foros y comités técnicos internacionales para reforzar nuestro conocimiento y desarrollar soluciones basadas en estándares abiertos

ZIV ofrece soluciones inteligentes para la automatización de redes de AT, MT y BT

Para Generación, integración de renovables, EPCs & Industria

TSO - Transmission System Operators

DSO - Distribution System Operators

Comercializadora, consumo residencial e industrial

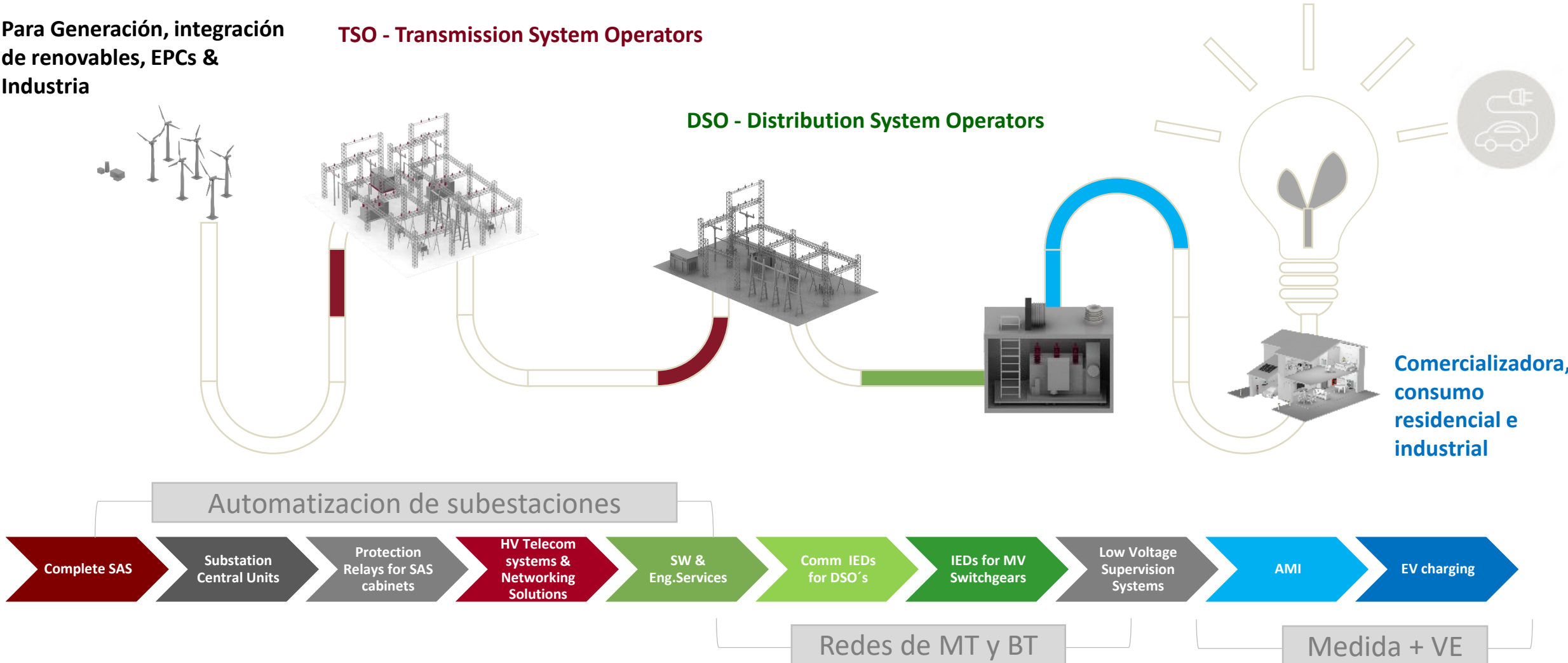

Trabajamos para compañías transmisoras, distribuidoras y comercializadoras de energía eléctrica. Así como para EPCs (Integradoras) e industria.



85
países

13 sites

- Zamudio (ESP)
- Barcelona (ESP)
- Madrid (ESP)
- Paris (FRA)
- Dublin (IRL)
- Newcastle (GBR)
- Niteroi (BRA)
- Mexico (MEX)
- Dubai (UAE)
- Bangalore (IND)
- Riyadh (KSA)
- Indonesia



Con soluciones basadas en 3 áreas de conocimiento

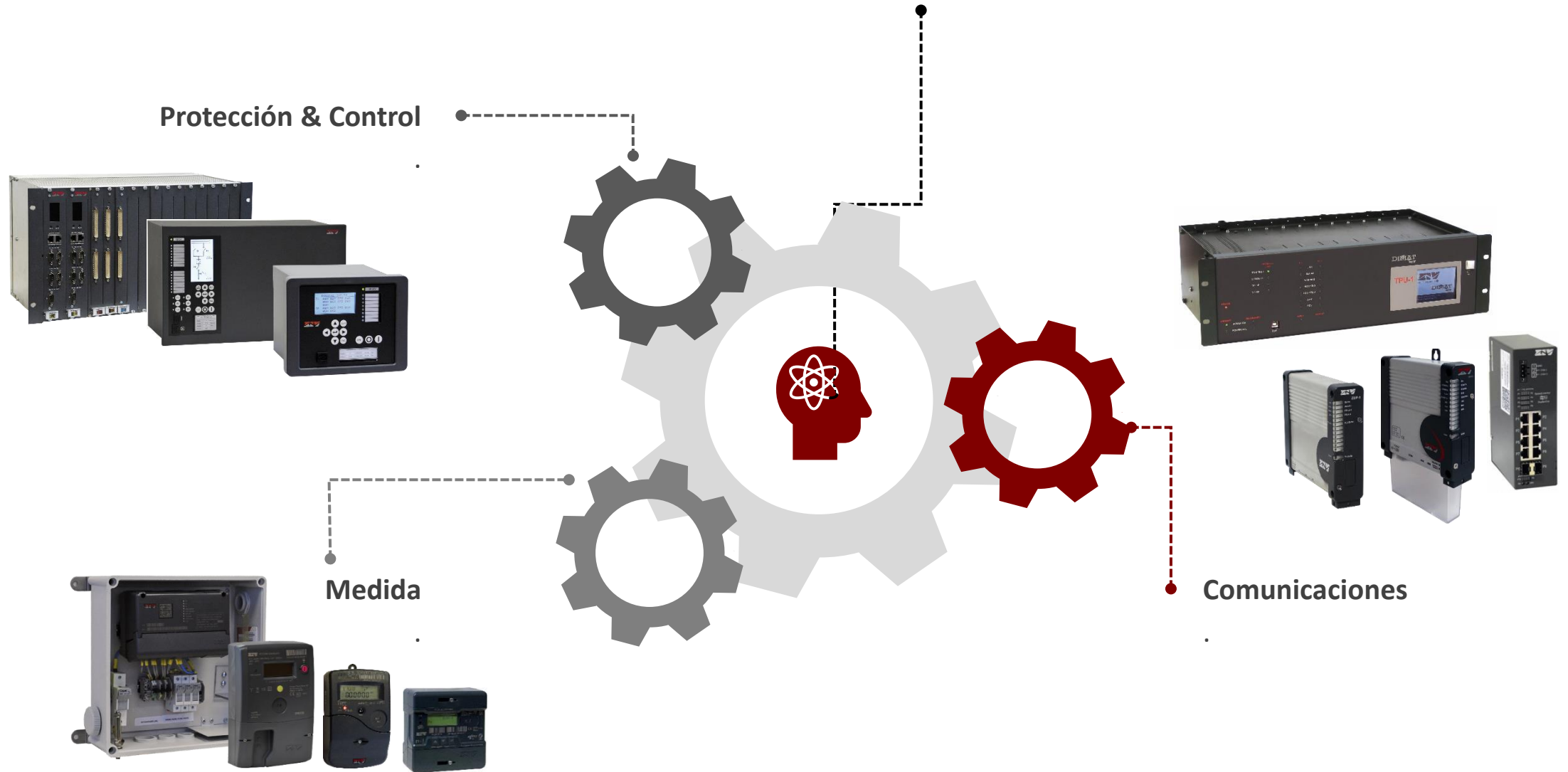





**Sistemas Integrados de Protección,
Control, Comunicaciones y Medida**

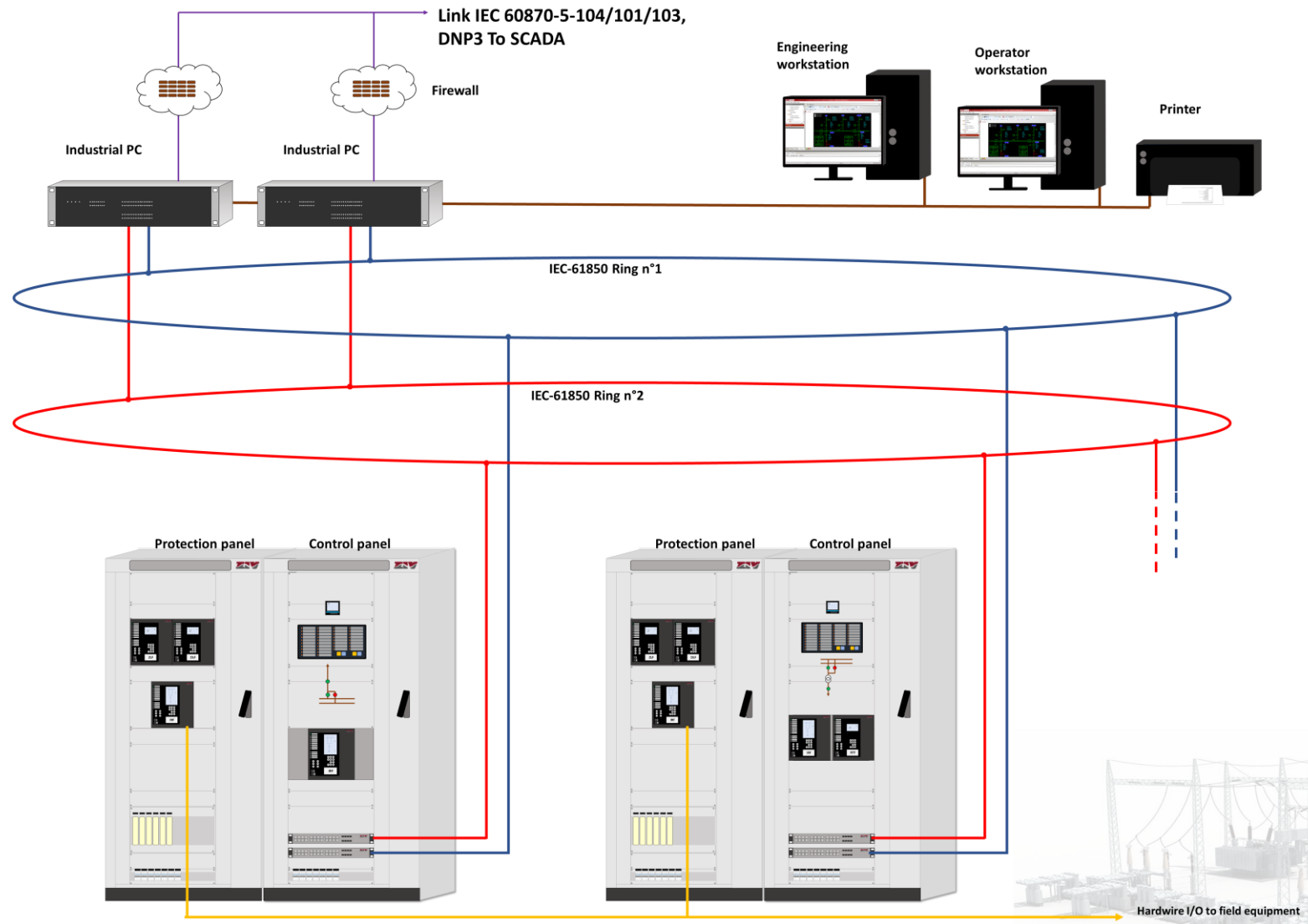

Soluciones completas para Automatización de Subestaciones



Basadas en un completo portfolio de:

- Unidades Centrales
- Relés de Protección y Control
- Telecomunicaciones en AT y networking
- SW
- Servicios de ingeniería





2

Soluciones Automatización y Supervisión de las redes de MT y BT

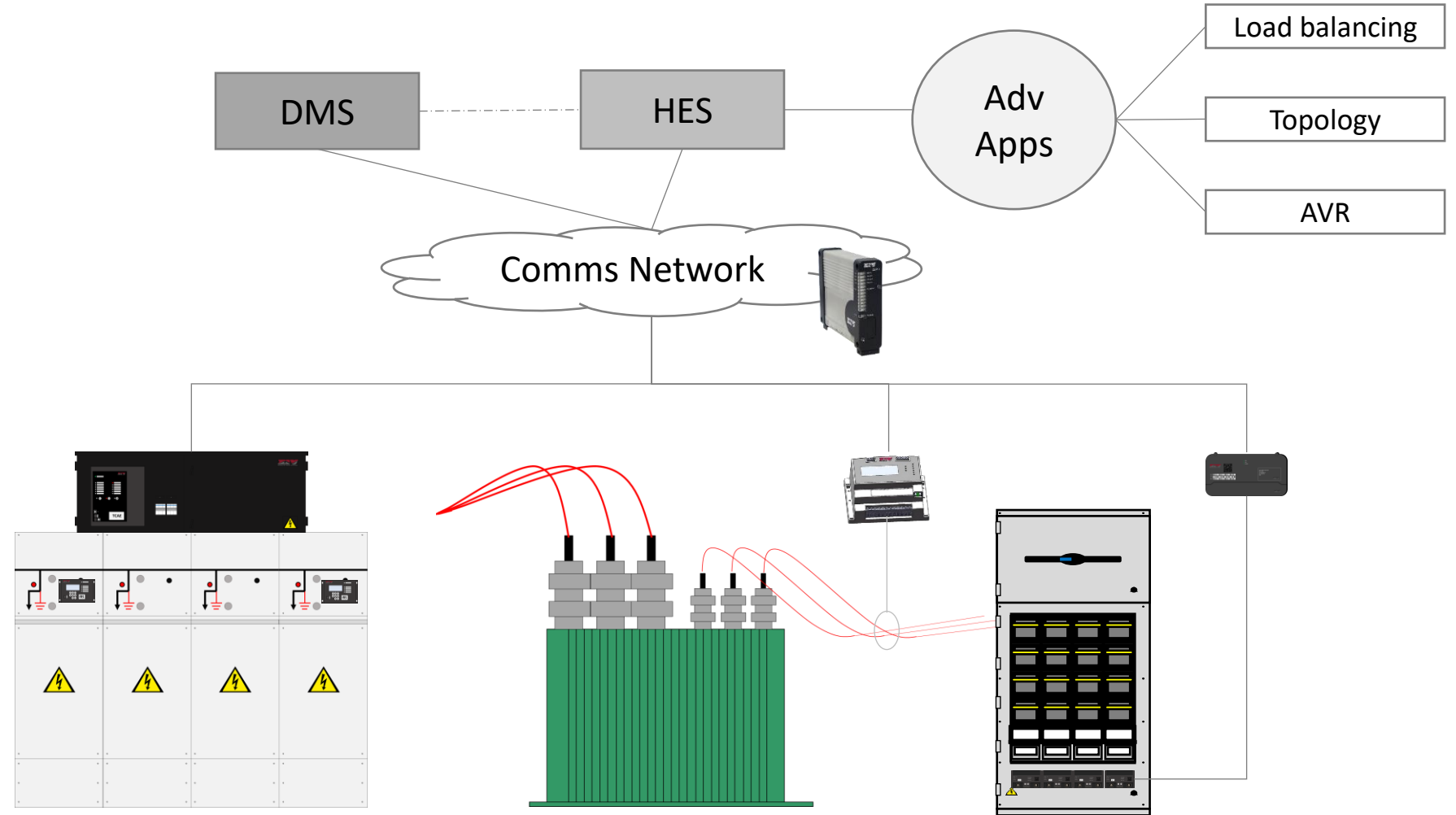

Distribution Automation Solutions

- Soluciones para MT (equipos de Automatización, Protección y Comunicaciones)
- MV Switchgear Automation
- Over Head MV Line Automation
- Supervisión avanzada de baja



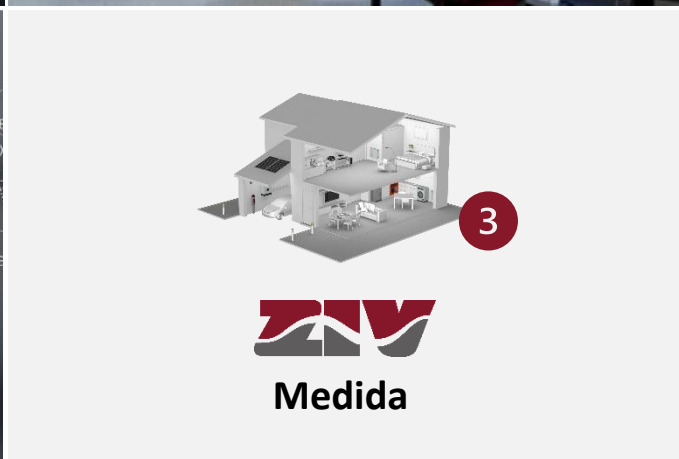
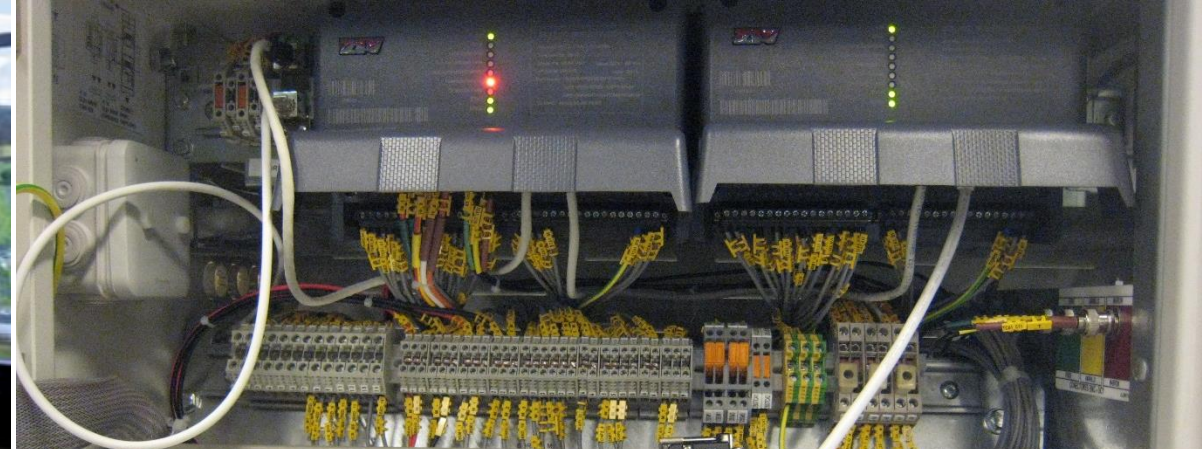

Somos la compañía pionera en el despliegue masivo de contadores. Hemos creado una completa gama de equipos y soluciones interoperables basadas en estándares.

Concentradores y Gateways

flexibilidad

STANDARD

4CCT DCU

4GWC Gateway

4TGB DCU con Comunicaciones integradas



LV

AMI

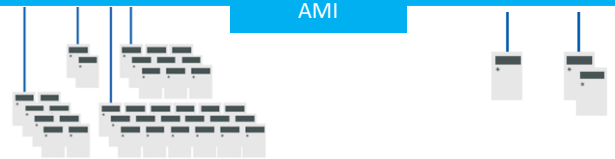

LTE

5CTA - ESMR5
1ph & 3ph 4G LTE Meters

RADIO

5CTA - SMETS 2
1ph Radio Meter

LTE

5CTM
1ph.

PLC

5CTD
3ph Direct

5CTCD
3ph CT Meter

5CTB
3ph Direct, CT & VT/CT

METERING SOLUTIONS PORTFOLIO

Modular meter





Conectadas

De fácil
instalación y uso

Escalables

Eficientes

Soluciones de Recarga AC inteligente

Seguras

Adaptables

ZIV Spot
Residencial/corporativo

PRV-VP
Público

PRV-M
Corporativo/Público

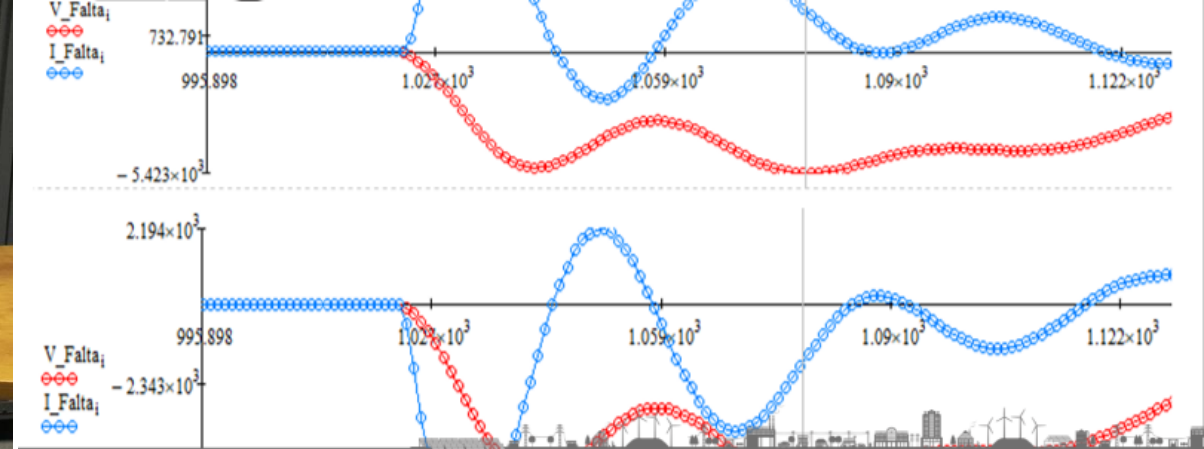

5
Formación

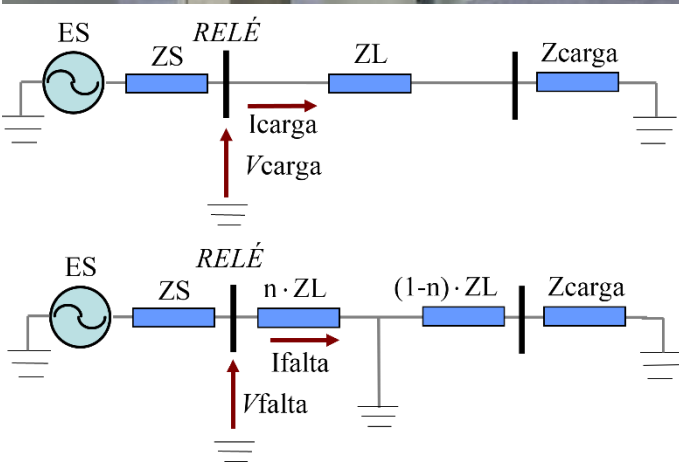

Tipos de Subestaciones

Interruptor y Medio

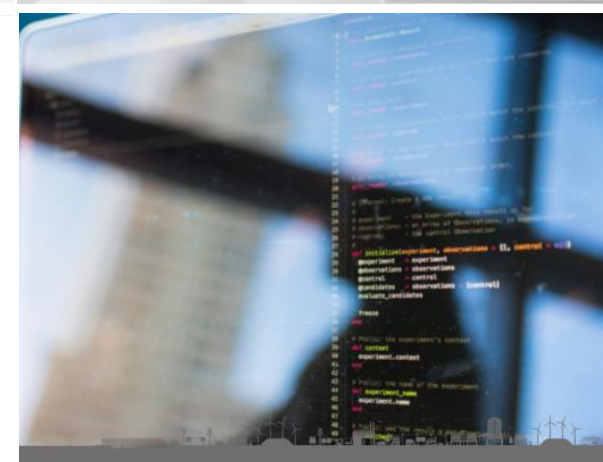

Formamos a clientes y distribuidores

gracias al conocimiento y la experiencia de nuestro equipo de ingeniería

a través de una plataforma online que les permite avanzar a su ritmo

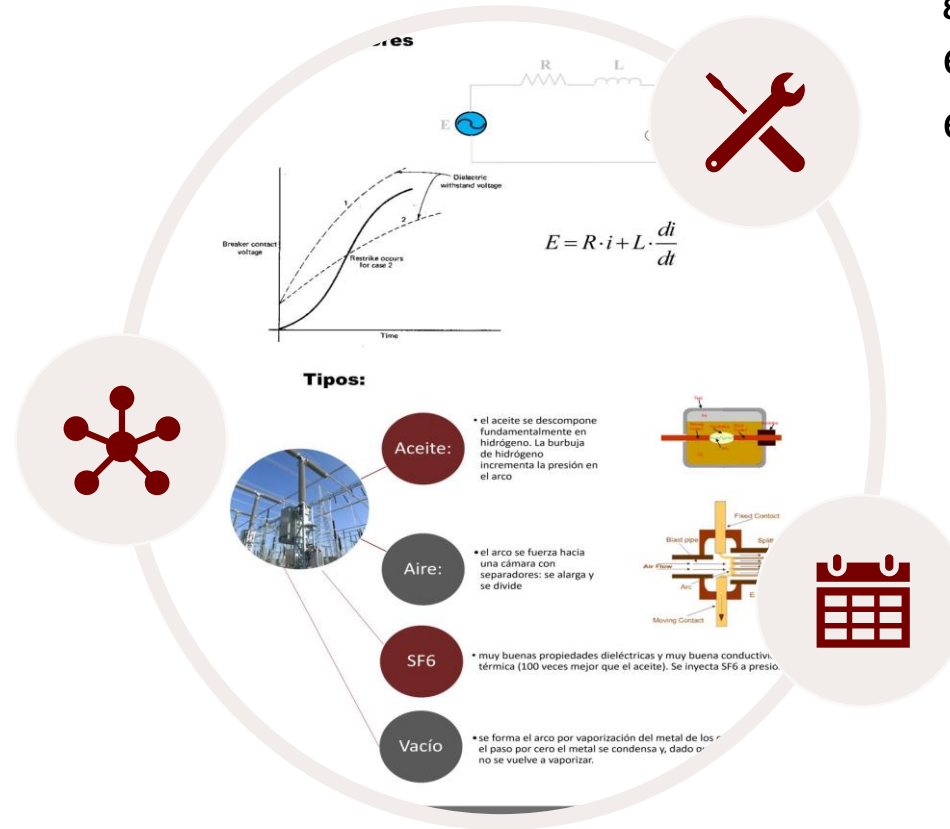

Visita nuestra web para conocer el calendario de formación y los contenidos ofertados.

Sigue nuestro canal de formación en





Thanks / Gracias

Daniel HERRERO

Global Sales Manager

Daniel.Herrero@zivautomation.com

